

Fittings / LED Floodlights

Skyline Powertron 1800W LED Asymmetric (WAB) Floodlight - 4200K



The Skyline Powertron Asymmetric LED Floodlight is the highest lumen output floodlight ever produced by BELL. The black powder coated die cast aluminium construction gives an ultra-modern aesthetic combined with a staggering 260,000 lumen output (1800W). The rugged, robust construction of the Powertron makes this fitting ideal for external sports facilities open to the elements.

- 600/1200/1800W Modular Body Design.
- Genuine replacement for 1000W/2000W Metal Halide Floodlights.
- Up to 157 Lm/W.
- Angle markings on bracket for easy alignment.
- Fully adjustable angled mounting bracket.
- Suitable for multiple row columns installation.
- Scope available on request for fine on site aiming.
- Full cut-off horizontal asymmetric floodlight.
- Optional ULR Shields available for 0% upward light, glare and obstructive light reduction.
- Remote driver gear tray, can be mounted on ground level for easy maintenance.

Technical Specification

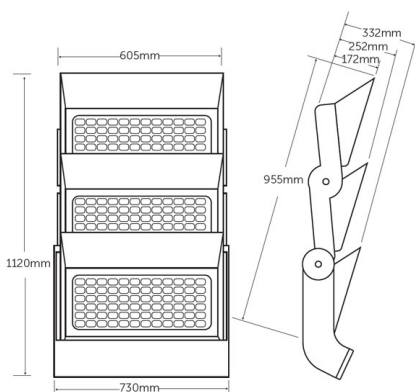

Product Code 11834

Reference

Guarantee	10 Years
EAN	5013588118345
Commodity Code	9405423990
Country of Origin	CN
UNSPSC Code	39111626

Technical Specification

Volts (V)	180/440
Watts (W)	1800
Colour Temp (K)	4200
Dimmable?	No
Lumens (lm)	280260
Life Hours	100000
CRI (ra)	70
Switching Cycles	200000
Frequency (Hz)	50/60
Energy Consumption (kWh/1000h)	1800
IP Rating	IP66
Impact Protection	IK8

Dimensions

Height (mm)	1100
Width (mm)	605
Depth (mm)	332

Packaging Information

Outer Box Qty	1
---------------	---